

Floors

Aluminum Inverted T Floor

Aluminum Non Slippery Textured Floor

Aluminum Textured Floor

Aluminum Extrusion Flat Floor

Laminated Oak Hardwood

Laminated Hardwood

Apitong Wood Floor

- ☺ If you don't see what you need here, please let us know.**
- ☺ We Carry Aluminum, Steel & Wood Floor.**
- ☺ We have counter sunk rivets to be used for Aluminum & Steel Floors.**

Aluminum Extrusions

Truckline Inc.

Call Us at **Tel: 201-887-2506**

Truck & Trailer Body Parts Mfg. & Sales

Web Site **WWW.TRUCKLINE-SALE.COM**

Description : **FLOOR - Inverted T floor (Non Slippery)**

Material: **Aluminum 6061-T6**

Part # **TL-FLOR-001-A-xx** **9" Board**

Size: **Up to 53' long**

-B-xx **Center Key**

-C-xx **Sides**

-D-xx **10" Board**

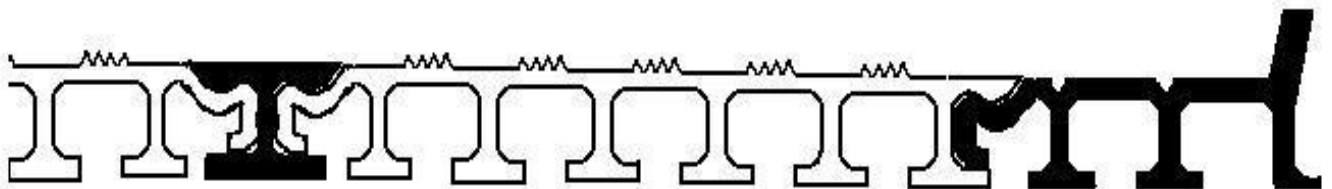
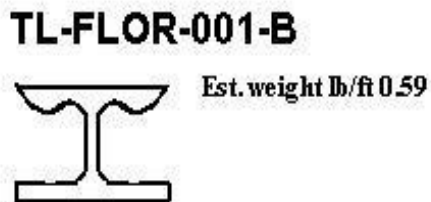
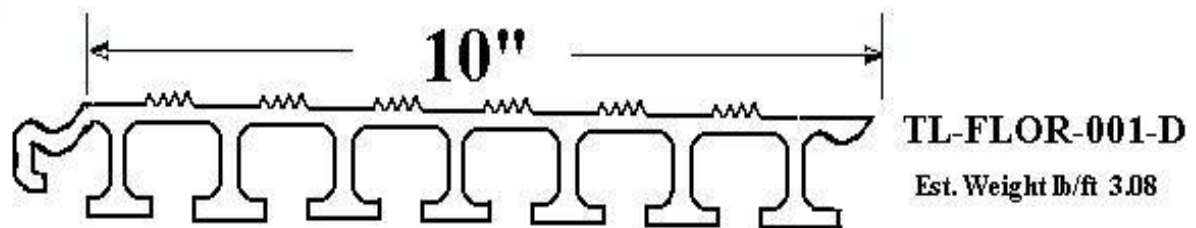
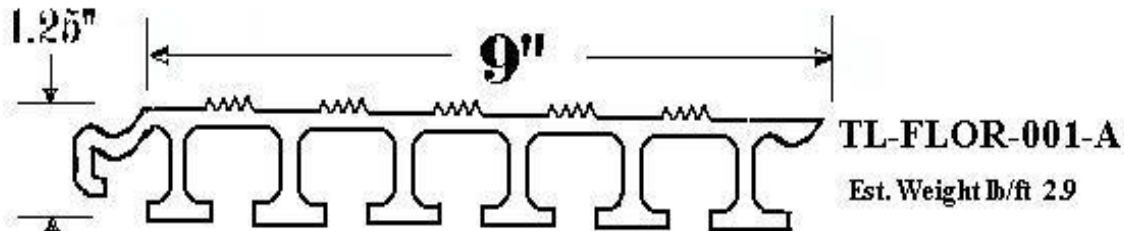

Aluminum Extrusions

Truckline Inc.

Call Toll Free **800-684-9799**

Truck & Trailer Body Parts Mfg. & Sales

Tel: 201-703-7933

Web Site **WWW.TRUCKLINE-SALE.COM**

Fax: 201-791-4588

Description : **FLOOR - Textured Floor (Non slippery)**

Material: **6061-T6**

Part # **TL-FLOR-007-A-xx**
-B-xx

Size: **Up to 53'**

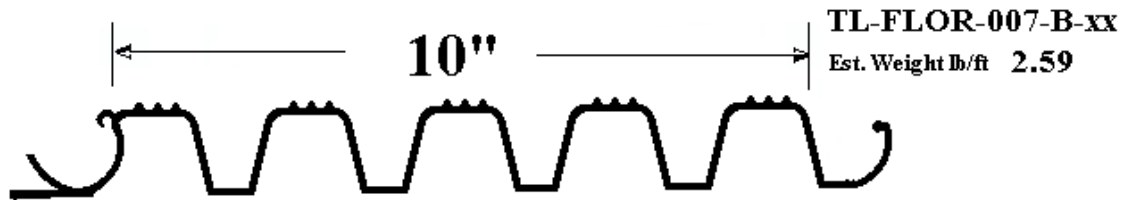
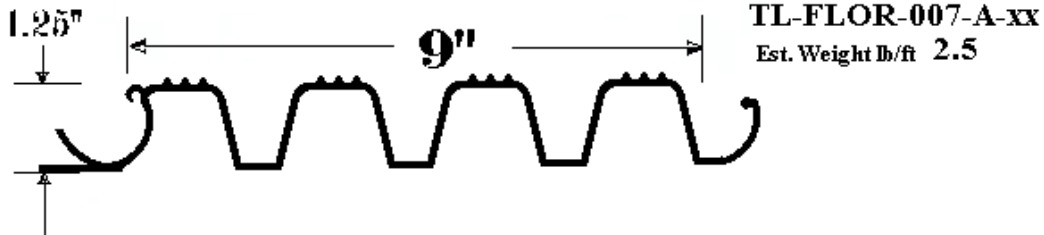

Width	Number of Boards when using End Boards & Key		Number of Boards when no End Boards are used	
	9" Boards	10" Boards	9" Boards	10" Boards
88"	3	5	2	7
89"	2	6	1	8
90"	1	7	0	9
91"	0	8	9	1
92"	9	0	8	2
93"	8	1	7	3
94"	7	2	6	4
95"	6	3	5	5
96"	5	4	4	6
97"	4	5	3	7
98"	3	6	2	8
99"	2	7	1	9
100"	1	8	0	10
101"	0	0	9	2
102"	9	1	8	3

Truckline Inc.

Call Toll Free **800-684-9799**

Truck & Trailer Body Parts Mfg. & Sales

Tel: **201-703-7933**

Web Site **WWW.TRUCKLINE-SALE.COM**

Fax: **201-791-4588**

Description : **FLOOR - Smooth Floor**

Material: **6061-T6**

Part # **TL-FLOR-010-A-LF - 7.875" Boards**

Size: Up to 53'

TL-FLOR-010-B-LF - 10.125" Boards

TL-FLOR-010-C-LF - Center Key

TL-FLOR-010-D-LF - Side Kike

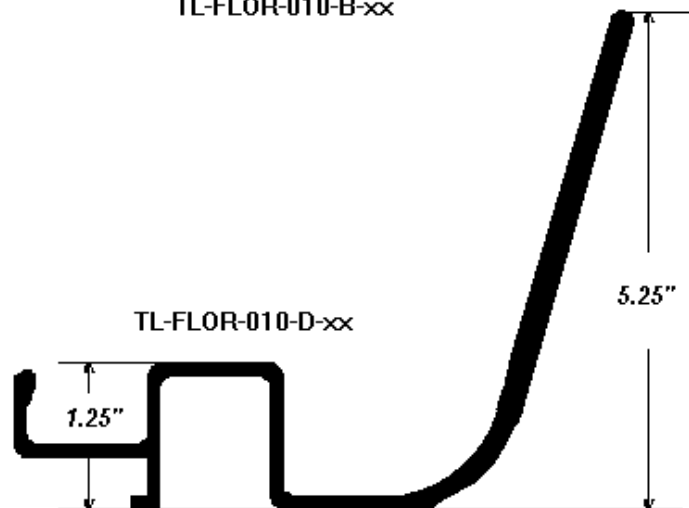
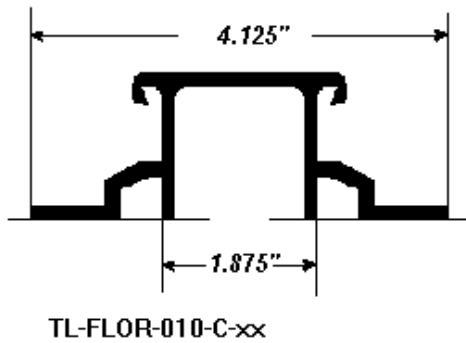
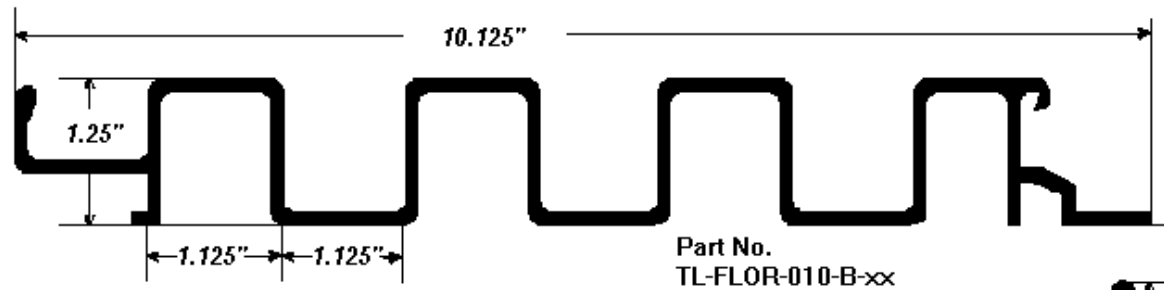
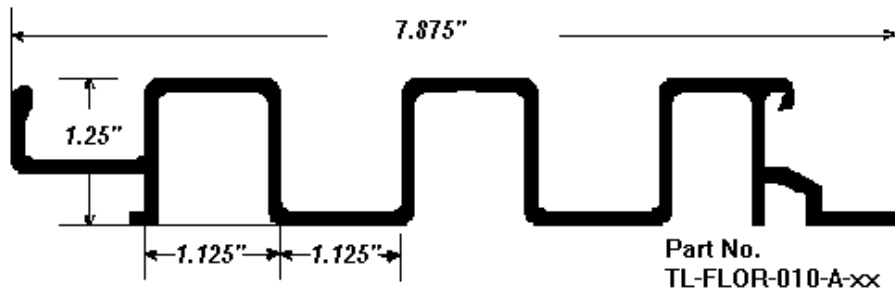

Truckline Inc.

Call Toll Free **800-684-9799**

Truck & Trailer Body Parts Mfg. & Sales

Tel: 201-703-7933

Web Site **WWW.TRUCKLINE-SALE.COM**

Fax: 201-791-4588

Description: **Light use Floor**

Material: 6061-T6

Part # **TL-AEXT-010-XX**

Approx. Weight/ft - **1.0 Lbs**

Size: **Up to 24'** in stock

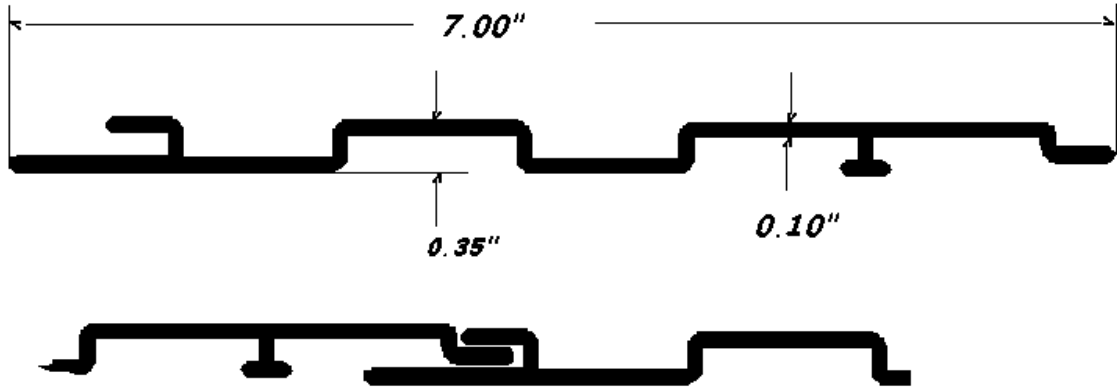

Part # **TL-AEXT-010-XX**

Truckline Inc.

Call Toll Free **800-684-9799**

Truck & Trailer Body Parts Mfg. & Sales

Tel: **201-703-7933**

Web Site **WWW.TRUCKLINE-SALE.COM**

Fax: **201-791-4588**

Description :

Solid Flooring for Truck, Trailer, Flatbeds or Platforms With 1/2" lap

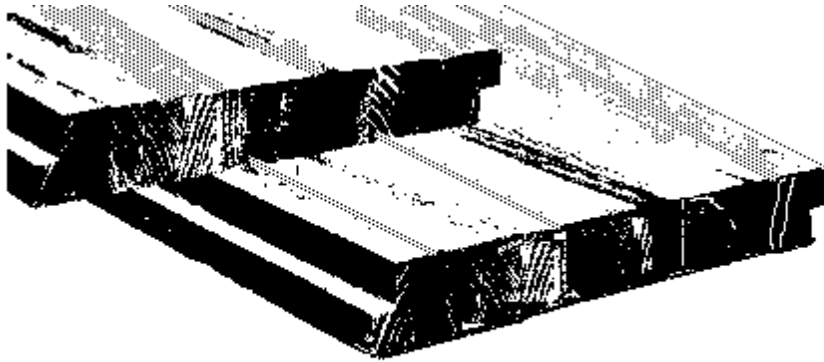

Part Number	Size*		Description
	Face	Thickness	
TL-Floor-004-A	5"	1-5/16"	Apitong/Keruing Length is varied
TL-Floor-004-B	5"	1-1/8"	Apitong/Keruing Length is varied
TL-Floor-005-A	7"	1-5/16"	Apitong/Keruing Length is varied
TL-Floor-005-B	7"	1-1/8"	Apitong/Keruing Length is varied
TL-Floor-006-B	4' x 8'	1-1/8"	Keruing/Kapur Treated Plywood (treated W/Babbillium to Australian quarantine requirements)
TL-Floor-008-A	11 3/4"	1-1/8"	Laminated Oak Length is made to size L/F
TL-Floor-008-B	11 3/4"	1-1/8"	Laminated Oak made to size S/F

Truckline Inc.

Call Toll Free **800-684-9799**

Truck & Trailer Body Parts Mfg. & Sales

Tel: 201-703-7933

Web Site **WWW.TRUCKLINE-SALE.COM**

Fax: 201-791-4588

Description : **Aluminum Tread Plate**

Material **3003 Bright Aluminum**

Part # **TL-FLOR-002**

Comment: **Stock Item**

Size Available:**1/8"x48"x96"**

Other Sizes Can Be Ordered

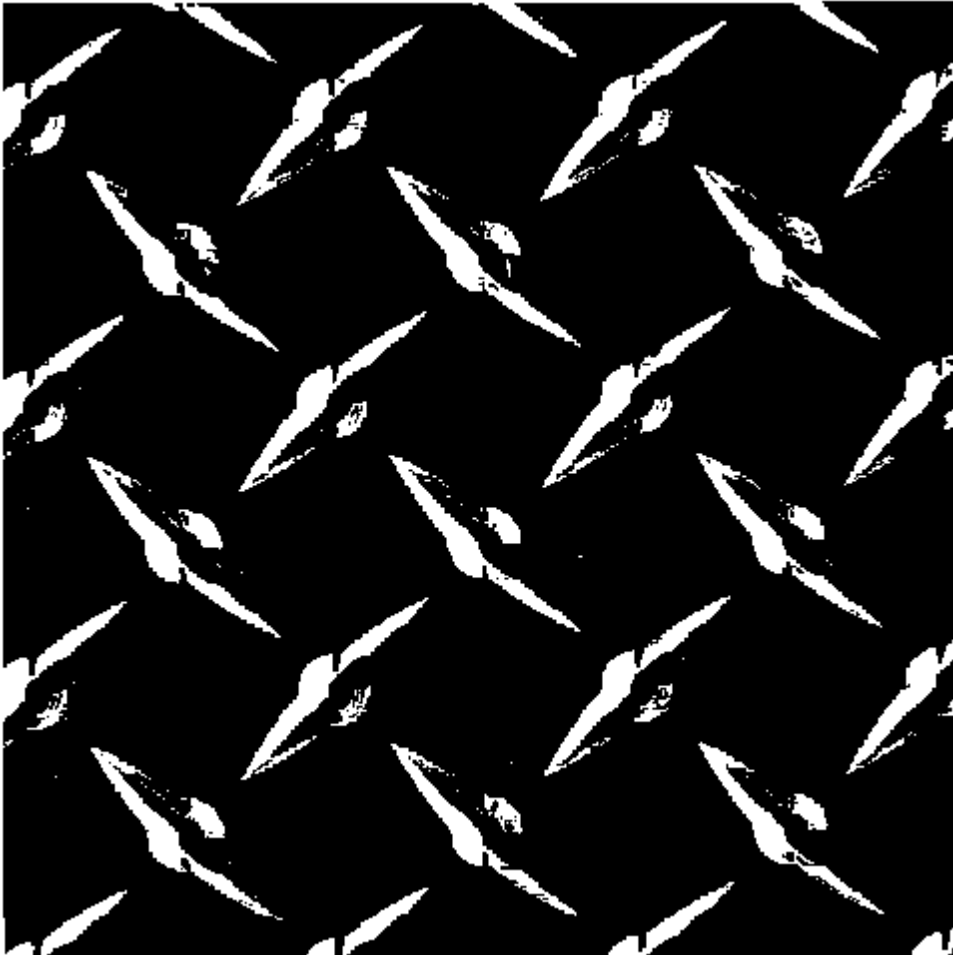

Description : **Steel Tread Plate**

Part # **TL-FLOR-003-01**

Comment: **Stock Item**

Size Available:**1/8"x48"x96"**

Other Sizes Can Be Ordered

Truckline Inc.

Call Toll Free **800-684-9799**

Truck & Trailer Body Parts Mfg. & Sales

Tel: 201-703-7933

Web Site **WWW.TRUCKLINE-SALE.COM**

Fax: 201-791-4588

Description : **FLOOR - Flat Inverted T floor**

Material: **Aluminum 6061-T6**

Part # **TL-FLOR-011-A-xx**

Size: **Up to 53' long**

